



**sifam tinsley**  
PRECISION INSTRUMENTATION

## *Delta* Energy



## Operating Manual



# DIGITAL MULTIFUNCTION INSTRUMENT

## Programmable Multi-function Digital Panel Meter

### Installation & Operating Instructions

<b>Section</b>	<b>Contents</b>
1.	Introduction
2.	Measurement Reading Screens
3.	Programming
3.1	Password Protection
3.2	Menu selection
3.2.1	System Parameter selection screen
3.2.1.1	System type
3.2.1.2	Potential transformer Primary value
3.2.1.3	Potential transformer secondary value
3.2.1.4	Current transformer Primary value
3.2.1.5	Current transformer Secondary value
3.2.1.6	Demand integration time
3.2.1.7	Auto Scrolling
3.2.1.8	No. of Poles Selection
3.2.1.9	Energy Display on Modbus
3.2.1.10	Energy Digit Reset count
3.2.2	Communication Parameter selection screen
3.2.2.1	Address Setting
3.2.2.2	RS 485 Baud rate
3.2.2.3	RS 485 Parity selection
3.2.3	Reset Parameter selection screen
3.2.3.1	Resetting Parameter
3.2.4	Output Option selection screen (menu)
3.2.4.1	Configuration of Output
3.2.4.1.1	Relay output selection menu
3.2.4.1.1.1	Pulse output

- 3.2.4.1.1.1 Assignment of Energy to Pulse
- 3.2.4.1.1.2 Pulse Duration Selection
- 3.2.4.1.1.3 Pulse Rate
- 3.2.4.1.2 Limit output
  - 3.2.4.1.2.1 Assignment of Limit Output to Parameter
  - 3.2.4.1.2.2 Limit Configuration
  - 3.2.4.1.2.3 Trip point selection
  - 3.2.4.1.2.4 Hysteresis selection
  - 3.2.4.1.2.5 Energizing delay time
  - 3.2.4.1.2.6 De-energizing delay time
- 3.2.5 Quit screen
- 4. Run - Hour
- 5. On - Hour
- 6. Number of Interruption
- 7. Negative Sign Indication
- 8. Relay Output
  - 8.1 Pulse output
  - 8.2 Limit Switch
- 9. RS 485 ( ModBus )
  - 9.1 User Assignable Modbus Register
- 10. Phaser Diagram
- 11. Installation
  - 11.1 EMC Installation Requirements
  - 11.2 Case Dimensions and Panel Cut-out
  - 11.3 Wiring
  - 11.4 Auxiliary Supply
  - 11.5 Fusing
  - 11.6 Earth / Ground Connections
- 12. Connection Diagrams
- 13. Optional Pluggable Module
- 14. Specification
- 15. Connection for Optional Pulse output / RS 485

**TABLE 1:**

<b>Measured Parameters</b>	<b>Units of measurement</b>
System Voltage	Volts
System Current	Amps
Frequency	Hz
Voltage L1-N(4wire only)	Volts
Voltage L2-N(4wire only)	Volts
Voltage L3-N(4wire only)	Volts
Voltage L1-L2	Volts
Voltage L2-L3	Volts
Voltage L3-L1	Volts
Current L1	Amps
Current L2	Amps
Current L3	Amps
System Active Power	KW
Active Power L1	KW
Active Power L2	KW
Active Power L3	KW
System reactive Power	KVAr
Reactive Power L1	KVAr
Reactive Power L2	KVAr
Reactive Power L3	KVAr
System Apparent Power	KVA
Apparent Power L1	KVA
Apparent Power L2	KVA
Apparent Power L3	KVA
System phase angle	Degree
Phase angle L1	Degree
Phase angle L2	Degree
Phase angle L3	Degree
System power factor	—

Power factor L1	—
Power factor L2	—
Power factor L3	—
Active Import Energy (8 Digit resolution)	KWh
Active Export Energy (8 Digit resolution)	KWh
Reactive Import Energy (8 Digit resolution)	KVArh
Reactive Export Energy (8 Digit resolution)	KVArh
Apparent Energy (8 Digit resolution)	KVAh
RPM	RPM
Max. Value System Voltage	V
Max. Value System Current	A
Min. Value System Voltage	V
Min. Value System Current	A
Current Demand	Amps
KVA Demand	KVA
KW Import Demand	KW
KW Export Demand	KW
Max. Current Demand	Amps
Max. kVA Demand	KVA
Max. KW Import Demand	KW
Max. KW Export Demand	KW
Run Hours	Hours
ON Hours	Hours
No. of Auxiliary Interruptions	Counts

## 1. Introduction

The Multifunction Meter is a panel mounted 96 x 96mm DIN Quadratic Digital Panel Meter, which measures important electrical parameters in 3 ph 4 wire / 3 wire / 1ph Network and replaces the multiple analog panel meters. It measures electrical parameters like AC voltage, Current, Frequency, Power, Energy(Active / Reactive / Apparent), phase angle, power factor & many more. The instrument integrates accurate measurement technology (All Voltages & current measurements are True RMS upto 15th Harmonic) with 3 line 4 digits Ultra high bright LED display with Clearly visible Annunciated units with bright LED from Back side.



The Multifunction Meter can be configured & Programmed on site for the following :  
 PT Primary, PT Secondary, CT Primary, CT Secondary (5A or 1A) & System  
 Type 3 phase 3W or 4W or single phase system.

The front panel has four push buttons for user interface to scroll through the available parameters.

These four keys has function as follow :

1. V/A : Selects & Scrolls through Voltage parameters display and phase current parameters display.
  2. P : Select & Scrolls phase & system Power parameters : Active power, apparent power, reactive power, phase angle, power factor, then system Apparent, Reactive, Active Power, Phase angle, Power factor, then Current demand, KVA demand, Max current demand, Max KVA demand, Active import demand, Max active import demand, Active export demand, Max active export demand and then back to Phase active power.
  3. E : Select & Scrolls through Energy parameters : Active energy (Import), Active energy (Export), Reactive energy (Import), Reactive energy (Export), Apparent energy and then back to Active energy (import).
  4. Sys : Select & Scroll through System parameters : Voltage-Current-Frequency, Hi values of system voltage and current, Lo values of system Voltage and current, RPM, run Hour, ON hour and no. of interruptions and back to System Voltage-Current Frequency screen.
- The Multifunction Meter come with 14mm display and units annunciated from back side, which enables to take reading from long distance. The problem with conventional LED annunciators is overcome with The Multifunction Meter

## 2. Measurement Reading Screens

In normal operation the user is presented with the measurement reading screens. These screens may be scrolled through one at a time by pressing the "V/A" key for Voltages and Currents, "P" key for phase Active, Reactive & apparent power, System Apparent, reactive & Active powers and all demand parameters. "E" key for Active energy (Import), Active energy (Export), Reactive energy (Import), reactive energy (Export) and Apparent energy, "Sys" key for System Voltage-Current - Frequency, max. and min. Values of system Voltage and Current, RPM, Run hours, ON hours, No. of Aux interruptions.

### a. "V/A" Key:

Screen 1 : Voltage Line to Neutral  
(For 3Ph4 Wire only)



Screen 2 : Voltage Line to Line  
(For 3Ph 4Wire & 3 Wire)



Screen 3 : Line Currents



### b. "P" Key:

Screen 1 : Phase Active power  
(For 3Phase 4 wire only)



Screen 2 : Phase Apparent power  
(For 3Phase 4 wire only)



Screen 3 : Phase Reactive power  
(For 3Phase 4 wire only)



Screen 4 : Phase Angle  
(For 3Phase 4 wire only)



Screen 5 : Phase power factor  
(For 3Phase 4 wire only)

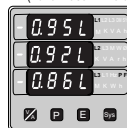

Screen 6 : System powers  
(Apparent, reactive, active)



Screen 7 : System Phase Angle  
& power factor (3P4W &3W )

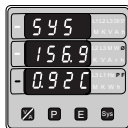

Screen 10 : Import kW Demand



Screen 8 : Current Demand/  
kVA Demand

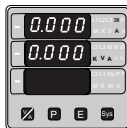

Screen 11 : Max Import kW Demand

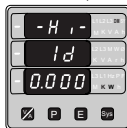

Screen 9 : Max Current Demand/  
Max kVA Demand



Screen 12 : Export kW Demand



Screen 13 : Max Export kW Demand

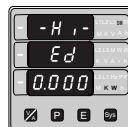

**c. "E" Key:**

Screen 1 : Active Energy(Import)

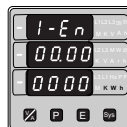

Screen 2 : Active Energy (Export)

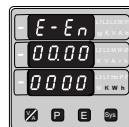

Screen 3 : Reactive Energy  
(Import)



Screen 4 : Reactive Energy  
(Export)



Screen 5 : Apparent Energy  
(Export)



d. "Sys" Key:

Screen 1 : System Values  
(Voltage, Current, Frequency)



Screen 2 : Max. Values



Screen 3 : Min. Values



Screen 4 : RPM Measurement

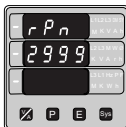

Screen 5 : Run Hours



Screen 6 : ON Hours



Screen 7 : No. of Interruptions

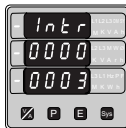

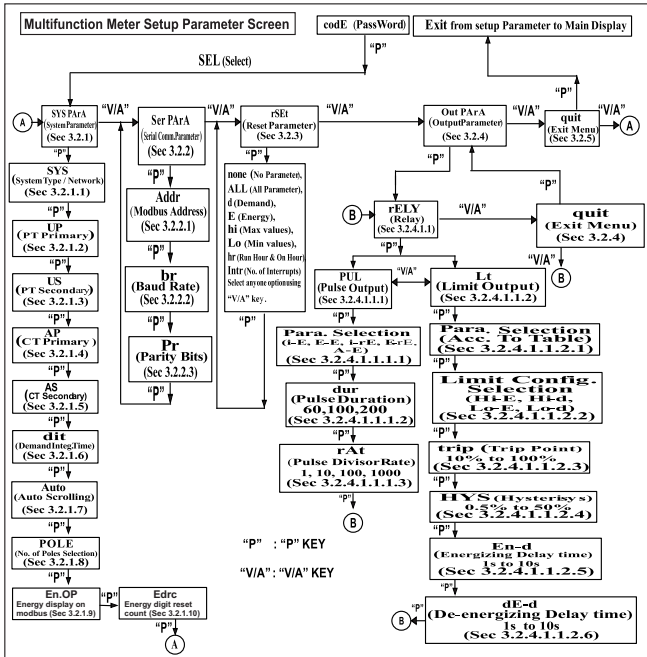

### 3. Programming

The following sections comprise step by step procedures for configuring the Multifunction Meter for individual user requirements.

To access the set-up screens press and hold the “V/A” and “P” key simultaneously for 5 seconds. This will take the User into the Password Protection Entry Stage (Section ).

#### 3.1. Password Protection

Password protection can be enabled to prevent unauthorised access to set-up screens, by default password protection is not enabled.

Password protection is enabled by selecting a four digit number other than 0000, setting a password of 0000 disables the password protection.



Enter Password, prompt for first digit. (\*Denotes that decimal Point will be flashing).

Press the “V/A” key to scroll the value of first digit from 0 through to 9, the value will wrap from 9 round to 0.

Press the “P” key to advance to next digit. In special case where the Password is “0000” pressing the “P” key when prompted for the first digit will advance to “Password confirmed” screen.

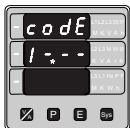

Enter Password, first digit entered, prompt for second digit. (\*Denotes that decimal Point will be flashing).

Use the “V/A” key to scroll the value of the second Digit from 0

through to 9, the value will wrap from 9 round to 0.

Press the “P” key to advance to next digit.



Enter Password, second digit entered, prompt for third digit. (\* Denotes that decimal point will be flashing).

Use the “V/A” key to scroll the value of the

third digit from 0 through to 9, the value will wrap from 9 round to 0.

Press the “P” key to advance to next digit.



Enter Password, third digit entered, prompt for fourth digit. (\*Denotes that decimal point will be flashing).

Use the “V/A” key to scroll the value of the

fourth digit from 0 through to 9, the value will wrap from 9 round to 0.

Press the “P” key to advance to verification of the password.

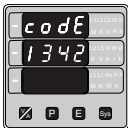

Enter Password, fourth digit entered, awaiting verification of the password.

### Password confirmed.



Pressing "V/A" key will advance to the "New / change Password" entry stage.

Pressing the "P" key will advance to the Menu selection screen. (See section 3.2).

### Password Incorrect.

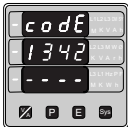

The unit has not accepted the Password entered.

Pressing the "V/A" key will return to the Enter Password stage.

Pressing the "P" key exits the Password menu & returns operation to the measurement reading mode.

### New / Change Password

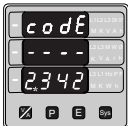

(\*Decimal point indicates that this will be flashing).

Pressing the "V/A" key will scroll the value of the first digit from 0 through to 9, the value will wrap from 9 round to 0.

Pressing the "P" key to advance the operation to the next digit and sets the first digit, in this case to "2"



New/ Change Password, first digit entered, prompting for second digit. (\*Decimal point indicates that this will be flashing).

Pressing the "V/A" key will scroll the value of the second digit from 0 through to 9, the

value will wrap from 9 round to 0.

Pressing the "P" key to advance the operation to the next digit and sets the second digit, in this case to "1"



New / Change Password, second digit entered, prompting for third digit. (\*decimal point indicates that this will be flashing).

Pressing the "V/A" key

will scroll the value of the third digit from 0 through to 9, the value will wrap from 9 round to 0.

Pressing the "P" key to advance the operation to the next digit and sets the third digit, in this case to "5"

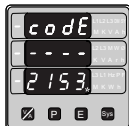

New/ Change Password, third digit entered, prompting for fourth digit. (\* denotes that decimal point will be flashing).

Pressing the "V/A" key will scroll the value of the fourth digit from 0 through to 9,

the value will wrap from 9 round to 0.

Pressing the "P" key to advance the operation to the "New Password Confirmed" & sets the fourth digit in this case to "3".

## New Password confirmed.



Pressing the "V/A" key will return to the "New/Change Password".

Pressing the "P" key will advances to the Menu selection screen. (see section 3.2).

## 3.2 Menu selection.

### 3.2.1 System Parameter selection screen.



This screen is used to select the different system Parameter like "system type," "CT

Ratio," "PT Ratio", Pressing the "P" key allows the user to set Different system parameters. (see section 3.2.1.1 to 3.2.1.8)

Pressing the "V/A" key will advance to Communication selection screen (see section 3.2.2)

### 3.2.2 Communication Parameter selection screen.



This screen is used to select the different communication parameters like "Address selection," "RS485 Parity selection," "RS485 baud rate".

Pressing the "P" key allows the user to set different Communication parameters

(see section 3.2.2.1 to 3.2.2.3) Pressing the "V/A" key will advance to Reset parameter Screen. (see section 3.2.3)

### 3.2.3 Reset Parameter selection screen.



This screen is used to Reset the different parameters.

Pressing the "P" key allows the user to Reset different system parameters (see section 3.2.3.1)

Pressing the "V/A" key will advance to Output Option selection screen (see section 3.2.4).

### 3.2.4 Output Option selection screen.

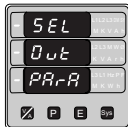

This screen will allow the user to select Output option Like "Relay" Output.

Pressing the "P" key allows the user to select & Configure the output option (see section 3.2.4.1)

Pressing the "V/A" key will advance to Quit screen. (see section 3.2.5)

### 3.2.5 Quit screen.

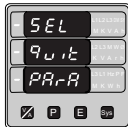

This screen will allow the user to Quit the Menu Pressing the "P" key will allow the user to Quit from menu & return to measurement screen.

Pressing the "V/A" key will advance to system Parameter Selection screen ( see section 3.2.1)

## 3.2.1 System parameters Selection

### 3.2.1.1 System Type



This screen is used to set the system type. System type "3" for 3 phase 3 wire, "4" for 3 phase 4 wire system & "1" for single phase system.

Pressing the "P" key accepts the present value and advances

to the "Potential transformer primary value Edit" menu (see section 3.2.1.2)

Pressing the "V/A" key will enter the system type edit mode & scroll the values through values available.

Pressing the "P" key advances to the system type confirmation menu.

#### System Type Confirmation



This screen will only appear following the edit of system type.

Pressing the "P" key sets the displayed value and will

advance to "Potential Transformer Primary Value Edit" menu. (See section 3.2.1.2)

Pressing the "V/A" key will return to the system type edit stage by blanking the bottom line of the display

### 3.2.1.2 Potential Transformer Primary Value

The nominal full scale voltage which will be displayed as the **Line to Line** voltages for all system types. The values displayed represent the voltage in **kilovolts** (note "K" annunciator).

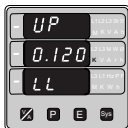

Pressing the "P" key accepts the present value and advances to the "potential Transformer secondary Value Edit" menu. (See Section 3.2.1.3)

Pressing the "V/A" key will enter the "Potential Transformer Primary Value Edit" mode.

Initially the "multiplier must be selected, pressing the "V/A" key will move the decimal point position to the right until it reaches #### after which it will return to #.###.

Pressing the "P" key accepts the present multiplier (decimal point position) and advances to the "potential Transformer primary Digit Edit" mode.

#### Note : PT Values must be set as Line to Line Voltage for Primary as Well as Secondary for all system types (3P3W/3P4W/1P2W).



Potential Transformer primary Digit Edit Pressing the "V/A" key will scroll the value of the most significant digit from 0 through to 9 unless the presently displayed Potential Transformer Primary Value

together with the Current Transformer Primary Value, previously set, would result in a maximum power of greater than 1000 MVA per phase in which case the digit range will be restricted.

Pressing the "P" key accepts the present value at the cursor position and advances the cursor to the next less significant digit.

The PT Primary value can be set from 100VL- L to 692.8kVL-L.

*Note : the flashing decimal point indicates the cursor position, a steady decimal point will be present to identify the scaling of the number until the cursor position coincides with the steady decimal point position. At this stage the decimal point will flash.*

When the least significant digit has been set pressing the "P" key will advance to the "Potential Transformer Primary Value Confirmation" stage.

Screen showing display of 0.120 kV i.e. 120 Volts indicating steady decimal point and cursor flashing at the "hundreds of volts" position.

### Potential Transformer Primary Value Confirmation



This screen will only appear following an edit of the Potential Transformer Primary Value.

If the scaling is not correct, pressing the "V/A" key will return to the "Potential

Transformer Primary Value Edit" stage with the digits flashing indicating that the multiplier (decimal point position) should be selected.

Pressing the "P" key sets the displayed value and will advance to the Potential Transformer secondary Value (See Section 3.2.1.3)

### 3.2.1.3 Potential Transformer secondary Value

The value must be set to the nominal full scale secondary voltage which will be obtained from the Transformer when the potential transformer (PT) primary is supplied with the voltage defined in 3.2.1.2.potential transformer primary voltage.

The ratio of full scale primary to full scale secondary is defined as the transformer ratio.

The PT Secondary value can be set from 100VL-L to 500VL-L.



Pressing the "P" key accepts the present value and advances to the "Current Transformer Primary Value edit" menu.(See Section 3.2.1.4)

Pressing the "V/A" key will enter the "Potential Transformer

Secondary Value Edit" mode. "V/A" key will scroll the value of the most significant digit from available range of PT secondary value. Please refer the table below for different ranges.

Pressing the "P" key accepts the present value at the cursor position and advances the cursor to the next less significant digit.

### Potential Transformer secondary ranges for various Input Voltages

Input Voltage Range (VL-L)	PT Secondary Range to be set (VL-L)
0 - 125 V	100V - 125 V
126V - 250 V	126V - 250 V
251V - 500 V	251V - 500 V

*Note : the flashing decimal point indicates the cursor position, a steady decimal point will be present to identify the scaling of the number until the cursor position coincides with the steady decimal point position. At this stage the decimal point will flash*

When the least significant digit has been set, pressing the "P" key will advance to the "Potential Transformer Secondary Value Confirmation" stage.

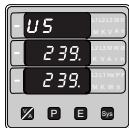

Potential Transformer Secondary Value Confirmation.

This screen will only appear following an edit of the Potential Transformer Secondary Value .

If the scaling is not correct, pressing the "V/A" key will return to the "Potential Transformer Secondary Value Edit"

Pressing the "P" key sets the displayed value and will advance to the current Transformer Primary Value (See Section 3.2.1.4)

### 3.2.1.4 Current Transformer Primary Value

The nominal Full Scale Current that will be displayed as the Line currents. This screen enables the user to display the Line currents inclusive of any transformer ratios, the values displayed represent the Current in Amps.

Pressing the "P" key accepts the present value and advances to the Current Transformer secondary Value (See Section 3.2.1.5)



Pressing the "V/A" key will enter the "Current Transformer Primary Value Edit" mode. This will scroll the value of the most significant digit from 0 through to 9, unless the presently displayed Current Transformer Primary Value

together with the Potential Transformer Primary

Value results in a maximum power of greater than 1000 MVA in which case the digit range will be restricted, the value will wrap. Example: If primary value of PT is set as 692.8kV-L (max value) then primary value of Current is restricted to 1736A.

Pressing the "P" key will advance to the next less significant digit. (\* Denotes that decimal point will be flashing).

The "Maximum Power" restriction of 1000 MVA refers to 120% of nominal current and 120% of nominal voltage, i.e, 694.4 MVA nominal power per phase.

When the least significant digit had been set, pressing the "P" key will advance to the "Current Transformer Primary Value Confirmation" stage.

The minimum value allowed is 1, the value will be forced to 1 if the display contains zero when the "P" key is pressed.



Current Transformer Primary Value Confirmation.

This screen will only appear following an edit of the Current Transformer Primary Value.

If the scaling is not correct, Pressing the "V/A" key will return to the "Current Transformer Primary Value Edit" stage with the most significant digit highlighted (associated decimal point flashing) and the bottom line of the display will be blanked.

Pressing the "P" key sets the displayed value and will advance to the "Current Transformer Secondary Value Edit" menu. (See Section 3.2.1.5)

### 3.2.1.5 Current Transformer Secondary Value



This screen is used to set the secondary value for Current Transformer. Secondary value "5" for 5A or "1" for 1A can be selected. Pressing "P" key accepts the present value and advances to the Demand

integration Time (See Section 3.2.1.6)

?Pressing the "V/A" key will enter the CT Secondary value edit mode and scroll the value through the values available.

Pressing the "P" key will advance to the CT Secondary value confirmation

#### CT Secondary value confirmation



This screen will only appear following an edit of CT secondary value. If secondary value shown is not correct, pressing the "V/A" key will return to CT secondary edit stage by blanking the bottom line of the display.

Pressing "P" key sets the displayed value and will advance to Demand integration Time Edit menu. (See Section 3.2.1.6)

### 3.2.1.6 Demand Integration Time



This screen is used to set the period over which current and power readings are to be integrated The Unit of displayed Readings is minutes.

Pressing the "V/A" key will scroll through the following Options 8,15,20,30.

Pressing the "P" key will advance to Demand Integration confirmation screen.

#### Demand Integration Time value confirmation

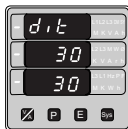

Pressing "P" key sets the displayed value and will advance to scroll screen. (See Section 3.2.1.7)

### 3.2.1.7 Auto Scrolling :



This screen allows user to enable screen scrolling.

Auto scrolling Edit.

Pressing "P" key accepts the present status and advance to the No. of Poles Selection (See Section 3.2.1.8).



Pressing the "V/A" key will enter the "Auto Screen Scrolling Edit" and toggle the status 'Yes' and 'No'.

Pressing the "P" key will select the status displayed

and advance to the No. of Poles Selection (See Section 3.2.1.8)

### 3.2.1.8 No. of Poles Selection

This screen enables to set No. of poles of a Generator of which RPM is to be measured and to which the instrument is connected to monitor its parameters.

#### Selection of No. of poles of the Generator



Pressing "P" key accepts the present value and advance to Energy Display on modbus (See section 3.2.1.9)

Pressing the "V/A" key will enter the "No. of Poles selection"

mode and scroll the number from 02 to 40 in step of 2. After 40 it scrolls the number again to 02.

#### No. of poles Confirmation



pressing the "V/A" key will re-enter the "No. of Poles Selection" mode.

Pressing "P" key set the number on screen as number of poles of generator & advance to Energy Display on modbus (See section 3.2.1.9)



Pressing the "V/A" key will enter the "Energy Display On Modbus Edit" mode and scroll the value through the values 1,2 & 3 wrapping back to 1  
1 : Energy In Wh  
2 : Energy in KWh  
3 : Energy in MWh.

Pressing the "P" key advances to the "Energy Display On Modbus Confirmation" menu.



This screen will only appear following an edit of the Energy Display On Modbus.

Pressing the "V/A" key will enter the "Energy Display On Modbus Edit" Edit" stage

by blanking the bottom line of the display.

Pressing "P" key sets the displayed value and will advance to the "Energy digit reset count" menu. (See section 3.2.1.10)

**Note : Default value is set to '1' i.e. Energy on Modbus will be in terms of Wh/VARh /VAh/Ah resp.**

#### 3.2.1.10 Energy Digit reset count :

This screen enables user for setting maximum energy count after which energy will reset to zero depending setting of Wh, KWh, & MWh.

Pressing the "P" key sets the displayed value and will jump back to the system parameter selection (See Section 3.2.1)

### 3.2.1.9. Energy Display on modbus

This screen enable user to set energy in terms of Wh / KWh / MKWh on RS 485 Output depending as per the requirement . Same applicable for all types of energy.

Pressing "P" key accepts the presents value and advances to the "Energy digit reset count" menu (See section 3.2.1.10).



Pressing the "V/A" key will enter the Energy digit reset count edit mode. This will scroll the value of reset count **from 7 to 14 for Wh, from 7 to 12 for KWh & from 7 to 9 for MWh.**

Ex. If energy o/p is set Wh & It will set Energy digit count to 10 then energy will reset after "9,999,999,999" & then will rollback to zero. Pressing "P key" will advance to Energy digit reset count confirmation screen.

Pressing the "V/A" key will re-enter Energy digit reset count edit mode.

Pressing the "P" key sets the displayed value and will jump back to the system parameter selection (See Section 3.2.1)

- Note :**
- 1) Default value is set to "14" i.e if energy count reaches to 14 digit it will rollback to zero.
  - 2) Energy displays on modbus is set to (2) & energy digit reset count is set to 12. Energy screen on display will show "-----" i.e overload .when energy crosses the 11 digit count.
  - 3) Energy displays on modbus is set to (3) & energy digit reset count is set to 9. Energy screen on display will show "-----" i.e overload .when energy crosses the 8 digit count.

## 3.2.2 Communication Parameter Selection :

### 3.2.2.1 Address Setting :



This screen applies to the RS 485 output only. This screen allows the user to set RS 485 parameter for instruments.

The range of allowable address is 1 to 247. Enter Address, prompt for first digit.

(\* Denotes that decimal point will be flashing). Press the "V/A" key to scroll the value of the first digit Press the "P" key to advance to next digit.



Enter Address, first digit entered, prompt for second digit (\* Denotes that decimal point will be flashing).

Use the "V/A" key to scroll the value of the second digit



Enter Address, second digit entered, prompt for third digit (\* Denotes that decimal

point will be flashing). Use the "V/A" key to scroll the value of the third digit



Enter Address for third digit.

Press the "P" key to advance to Address confirmation Screen.



Address confirmation Screen.

This Screen confirms the Address set by user. Press the "P" key to advance to next Screen "Rs485 Baud Rate" (See Section 3.2.2.2)

Pressing the "V/A" key will re-enter the "Address Edit" mode.

### 3.2.2.2 RS 485 Baud Rate :



This screen allows the user to set Baud Rate of RS 485 port. The values displayed on screen are in kbaud. Pressing "P" key accepts the present value and advance to the Parity Selection (See Section 3.2.2.3)

Pressing the "V/A" key will enter the "Baud Rate Edit" mode and scroll the value through 2.4, 4.8, 9.6 , 19.2 & back to 2.4

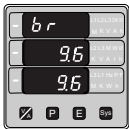

RS 485 Baud Rate confirmation :

Pressing "V/A" key will be re-enter into the Baud Rate Edit mode.

Pressing the "P" key will select the value and advances to the Parity Selection (See Section 3.2.2.3).

### 3.2.2.3 RS 485 Parity Selection:

This screen allows the user to set Parity & number of stop bits of RS 485 port.



Pressing "P" key accepts the present value and advance to Menu selection (see section 3.2).

Pressing the "V/A" key will enter the "Parity & stop bit Edit" mode & scroll the value through

**odd** : odd parity with one stop bit  
**no 1** : no parity with one stop bit  
**no 2** : no parity with two stop bit  
**E** : even parity with one stop bit

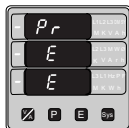

RS 485 Parity confirmation :

Pressing "V/A" key will be re-enter into Parity Edit mode.

Pressing the "P" key will set the value.

Pressing the "P" key again will jump back to the communication parameter selection menu (see section 3.2.2).

## 3.2.3 Reset Parameter Selection :

### 3.2.3.1 Resetting Parameter

The following screens allow the users to reset the all Energy, Lo(Min), hi(Max),Demand,Run hour., On hour, No.of interrupts



Reset (None)

Pressing "P" key advances to Reset Parameter selection screen (see section 3.2.3)

Pressing the "V/A" key will enter the "Reset option" mode

& scroll through Parameter and wrapping back to None.



Reset option select, (Resets ALL resettable parameter)

The user has scrolled through to the "ALL" .

Pressing "P" key will select the value and advance to the

"Reset ALL Confirmation" Mode &. Will reset all resettable parameter.



Reset ALL Confirmation.

Pressing the "V/A" key will re-enter the Reset option Select mode.

Pressing "P" key will jump back to the Reset Parameter

selection screen (see section 3.2.3).



Reset option select, (Reset A Demand, KVA Demand Parameters KW demand (Import/Export))

The user has scrolled through to the "d".

Pressing "P" key will select the value and resets all Demand parameters.



Reset Demand parameters Confirmation.

Pressing the "V/A" key will re-enter the "Reset option Select mode. Pressing "P" key will jump

back to the Reset Parameter selection screen (see section 3.2.3).



Reset option select, (Resets all Energies)

The user has scrolled through to the "E" Energy value.

Pressing "P" key will select the value and advance to the "Reset Energy

Confirmation" Mode. & resets all Energies (Import Energy, Export Energy Import reactive, Export reactive, Apparent Energy).



Reset Energy Confirmation.

Pressing the "V/A" key will re-enter the "Reset option" mode.

Pressing "P" key will jump back to the Reset Parameter

selection screen (see section 3.2.3).



Reset option select, (Reset Hi)

The user has scrolled through to the "Hi" (Max)

Pressing "P" key will select the value and advance to the

"Reset Hi Confirmation" Mode. Will reset Maximum (Hi) values of Voltage & Current Avg. appeared at input.



Reset hi (Max) Confirmation.

Pressing the "V/A" key will re-enter the "Reset option Select" mode.

Pressing "P" key will jump

back to the Reset Parameter selection screen (see section 3.2.3).



Reset option select, (Reset Lo)

The user has scrolled through to the "Lo" (Min)

Pressing "P" key will select the value and advance to the

"Reset Lo Confirmation" Mode & Will reset minimum values of Voltage & Current Avg. appeared at Input.



Reset Lo Confirmation

Pressing the "V/A" key will re-enter the "Reset option Select mode.

Pressing "P" key will jump back to the Reset Parameter

selection screen (see section 3.2.3).



Reset option select, hr (ON Hour & Run Hour)

The user has scrolled through to the "hr" Pressing "P" key will select the value and advance to the "Reset hr Confirmation" Mode & Will

reset On hour & Run Hour both.



Reset hr Confirmation

Pressing the "V/A" key will re-enter the "Reset option Select mode.

Pressing "P" key will jump back to the Reset Parameter

selection screen (see section 3.2.3).

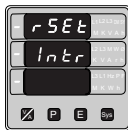

Reset option select, (Reset Number of Interrupt)  
The user has scrolled through to the "intr"

Pressing "P" key will select the value and advance to

the "reset Interrupt Confirmation" Mode & Will reset number of Auxiliary supply interruption count.

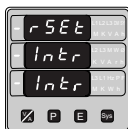

Reset Interrupt Confirmation

Pressing the "V/A" key will re-enter the "Reset parameter Selection" (see section 3.2.3).

Pressing "P" key will jump back to the Reset Parameter selection screen (see section 3.2.3)

## 3.2.4. Output Option selection menu

### 3.2.4.1 Configuration of Output



This screen applies to the Relay Output option Selection.

Pressing "P" key will select the Relay output selection menu (See section 3.2.4.1.1).

Pressing the "V/A" key will advance to the Quit screen



This screen allows the user to quit the output option

Pressing "P" key will advance to the Output Parameter selection (See section 3.2.4)

Pressing the "V/A" key will go back to Relay output option (See section 3.2.4.1).

### 3.2.4.1.1 Relay output Selection menu :

#### 3.2.4.1.1.1 Pulse output :



This screen is used to assign Relay in Pulse output mode

Pressing "P" key will advance to the Pulse output configuration (See section 3.2.4.1.1.1.1)

Pressing "V/A" key will show "Limit" output option (See section 3.2.4.1.1.2)

#### 3.2.4.1.1.2 Limit output :



This screen is used to assign Relay in limit output mode.

Pressing "P" key will assign Limit output mode (See section 3.2.4.1.1.2.1).

Pressing the "V/A" key will go back to the pulse option Screen (See section 3.2.4.1.1.1)

#### 3.2.4.1.1.1.1 Assignment of Energy to pulse output :

This screen allows the user to assign pulse output to energy.

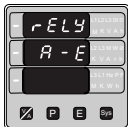

Pressing "P" key accepts the present setting and advance to "Pulse duration selection" (see section 3.2.4.1.1.1.2).

Pressing the "V/A" key will enter into edit mode and scroll through the energy setting

A - E : Apparent Energy

I - E : Import Energy (Active)

E - E : Export Energy (Active)

I - rE : Import Reactive Energy

E - rE : Export Reactive Energy



Pulse output confirmation:

Pressing "V/A" key will be re-enter into edit mode.

Pressing the "P" key will set the value & advances to the " Pulse duration

selection" (see section 3.2.4.1.1.1.2).

#### 3.2.4.1.1.1.2 Pulse Duration Selection:

This screen applies only to the Pulsed output mode of relay.

This screen allows the user to set Relay energisation time in milliseconds.

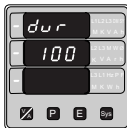

Pulse Duration Edit.

Pressing "P" key accepts the present value and advance to pulse rate selection menu ( see section 3.2.4.1.1.1.3).

Pressing the "V/A" key will enter the "Pulse Duration Edit" mode and scroll the value through 60, 100, 200 and wrapping back to 60.

Pressing the "P" key will select the value and advances to "Pulse Duration Confirmation".



#### Pulse Duration Confirmation.

This screen will only appear following an edit of the Pulse duration.

pressing the "V/A" key will re-enter the "Pulse Duration Edit" mode.

Pressing "P" key set displayed value and Will advance to pulse rate selection menu (See section 3.2.4.1.1.1.3)

#### 3.2.4.1.1.1.3 Pulse Rate

This screen applies to the Relay Output option only. The screen allows user to set the energy pulse rate divisor. Divisor values can be selected through 1,10,100,1000.



Pressing "P" key accepts the present value and advances to the "Configuration of output" (See section 3.2.4.1).

Pressing the "V/A" key will enter the "Pulse rate

divisor Edit" mode & scroll the value through the values 1,10,100, 1000 wrapping back to 1. Pressing the "P" key advances to the "Pulse rate Divisor Confirmation" menu.



#### Pulse Rate Divisor Confirmation.

This screen will only appear following an edit of the Pulse rate divisor

If the Pulse rate shown is not correct, pressing the "V/A" key will return to the "Pulse rate divisor Edit" stage by blanking the bottom

line of the display.

Pressing "P" key sets the displayed value and will advance to the "Configuration of output". (See section 3.2.4.1)

#### 3.2.4.1.1.2.1 Assignment of Limit output to parameter.

This screen is for Limit output mode selection. It allows the user to set Limit output corresponding measured value. Refer Table 2 "Parameter for Limit output" for assignment.



Pressing "P" key accepts the present value and advance to the Limit configuration select screen. (see section 3.2.4.1.1.2.2 ).

Pressing the "V/A" key will enter the "Limit output Edit"

mode and scroll the values, as per Table 2, "Parameter for Limit Output"

Pressing the "P" key advance to the Limit output confirmation screen .



Limit output Confirmation : Pressing the "V/A" key will re-enter the " Limit output Edit"

Pressing the "P" key sets the displayed value & will

advance to the Limit Configuration select screen (see section 3.2.4.1.1.2.2 )

### 3.2.4.1.1.2.2 Limit Configuration select

This screen is used to set the Limit Configuration, four different types of configuration can be selected

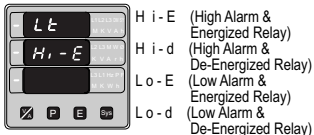

(For detail refer to section 8.2)

Pressing the "P" key accepts the present value and advances to the "Trip point selection" screen (see section 3.2.4.1.1.2.3)

Pressing the "V/A" key will enter the Limit Configuration edit mode and scroll through the Modes available.

Pressing the "P" key advances to the Limit configuration type confirmation menu.

### Limit Configuration Confirmation



This screen will only appear following the edit of Limit Configuration. If Limit Configuration is to be changed again,

pressing the "V/A" key will return to the Limit configuration Type edit stage

by blanking the bottom line of the display.

Pressing the "P" key sets the displayed value & will advance to "Trip point selection" Screen (See section 3.2.4.1.1.2.3)

### 3.2.4.1.1.2.3 Trip point selection :

This screen applies to the Trip point selection. This screen allows the user to set Trip point for instruments



The allowable range is 10% to 120% for High Alarm (refer table 2). The allowable range is 10% to 100% for Low Alarm.

Enter value, prompt for first digit (\* Denotes that decimal point will be flashing).

Press the "V/A" key to scroll the values of the first digit.

Press the "P" key to advance to next digit.



The first digit entered, prompt for second digit (\* Denotes that decimal point will be flashing).

Use the "V/A" key to scroll the value of the second digit.

Press the "P" key to advance to next digit.

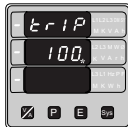

The second digit entered, prompt for third digit (\* Denotes that decimal point will be flashing).

Use the "V/A" key to scroll the value of the third digit.



Entered the value for third digit.

Press the "P" key to advance to trip point confirmation Screen.



Value confirmation Screen :  
This Screen confirms the value set by user.  
Press the "P" key to advance to next Screen  
"Hysteresis selection"  
(see section 3.2.4.1.1.2.4).  
Pressing the "V/A" key will return in edit mode.

#### 3.2.4.1.1.2.4 Hysteresis selection :

This screen applies to the Hysteresis selection.



This screen allows the user to set Hysteresis for relay output  
The allowable range is 0.5% to 50 % of Trip point.  
Enter value, prompt for first digit.

(\* Denotes that decimal point will be flashing).

Press the "V/A" key to scroll the value of the first digit

Press the "P" key to advance to next digit.

**Hysteresis for Frequency** is calculated as % of trip point span from 40Hz. e.g. If trip point is 50%(55Hz) and hysteresis is set to 10%, then relay will reset at 53.5Hz [10% of (55 - 40Hz) 15Hz is 1.5Hz. Hence, 55 - 1.5= 53.5Hz]

**Note :** In case of I<sub>o</sub> alarm if trip point is set at 100% then maximum 20% Hysteresis can be set.



The first digit entered, prompt for second digit  
(\* Denotes that decimal point will be flashing).  
Use the "V/A" key to scroll the value of the second digit.  
Press the "P" key to advance to next digit



The second digit entered, prompt for third digit  
(\* Denotes that decimal point will be flashing).

Use the "V/A" key to scroll the value of the third digit.



Entered value for third digit.

Press the "P" key to advance to Hysteresis confirmation Screen.



Hysteresis confirmation Screen :

This Screen confirms the percentage value set by user. & Screen will appear only after edit mode of Hysteresis.

Press the "P" key to advance to next Screen  
"Energizing delay time" ( 3.2.4.1.1.2.5 ).

### 3.2.4.1.1.2.5 Energizing Delay time.



This screen allows the user to set Energizing Delay time in seconds for Relay Limit Assigned Parameters

Pressing "P" key accepts the present value and advance to De-energizing delay screen.

Pressing the "V/A" key will enter the "Energizing Delay" Edit mode and scroll the "Value" through 1 to 10.

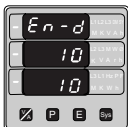

Energizing delay time Confirmation :

This screen will appear only after edit mode of Energizing delay time.

Pressing the "V/A" key will re-enter the "Energizing delay Edit" mode.

Pressing "P" key set displayed value & will advance to Assignment of De-energizing delay time. (See section 3.2.4.1.1.2.6 )

### 3.2.4.1.1.2.6 De-Energizing Delay time.

This screen allows the user to set De-Energizing Delay time in seconds for Relay Limit Assigned Parameters .



Pressing "P" key accepts the present value and advance to Configuration of output. (See section 3.2.4.1)

Pressing the "V/A" key will enter the "De-Energizing Delay" Edit mode and scroll

the "Value" through 1 to 10.

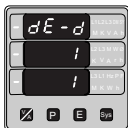

De-Energizing delay time

Confirmation :

This screen will appear only after edit mode of De-energizing delay time. pressing the "V/A" key will re-enter the "De-energizing delay Edit" mode.

Pressing "P" key set displayed value & will advance to Configuration of output. (See section 3.2.4.1)

## 4. Run Hour



This Screen shows the total no. of hours the load is connected Even if the Auxiliary supply is interrupted count of Run hour will be maintained in internal memory & displayed in the format "hours. min".

For example if Displayed count is 105000.10 r-H it indicates 105000 hours & 10 minutes. After 999999.59 run hours display will restart from zero. To reset run hour manually see section Resetting Parameter 3.2.3.1

## 5. On Hour



This Screen shows the total no. of hours the Auxiliary Supply is ON. Even if the Auxiliary supply is interrupted count of On hour will be maintained in internal memory & displayed in the format "hours. min".

For example if Displayed count is 005000.10 On-H it indicates 005000 hours and 10 minutes. After 999999.59 On hours display will restart from zero. To reset On hour manually see section Resetting Parameter 3.2.3.1

## 6. Number of Interruption :



This Screen Displays the total no. of times the Auxiliary Supply was Interrupted. Even if the Auxiliary supply is interrupted count will be maintained in internal memory. To reset No of Interruption manually see section

Resetting Parameter 3.2.3.1

## 7. Negative sign indication

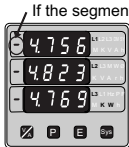

If the segment glows, it indicates negative sign of displayed parameter. When Power factor lies in second and third quadrant, it has -ve sign, so active power has -ve sign as shown in the phaser diagram.

Also in 3rd & 4th quadrant, reactive power is -'ve. So the -'ve annunciator glows to indicate the operation of system in respective mode as per the Phaser diagram shown on page 45. For example in the screen shown, Input values were 240V<sub>L-N</sub>, 20A, and phase angle 187° hence the phase active power is displayed with -'ve sign.

**TABLE 2 : Parameter for Limit output**

Parameter No.	Parameter	3P 4W	3P 3W	1P 2W	Trip Point Set Range	100% Value
0	None	✓	✓	✓	—	—
1	Volts 1	✓	✓	✓	10 - 120 %	Vnom (L-N)
2	Volts 2	✓	✓	✗	10 - 120 %	Vnom (L-N)
3	Volts 3	✓	✓	✗	10 - 120 %	Vnom (L-N)
4	IL1	✓	✓	✓	10 - 120 %	Inom
5	IL2	✓	✓	✗	10 - 120 %	Inom
6	IL3	✓	✓	✗	10 - 120 %	Inom
7	W1	✓	✗	✓	10 - 120 %	Nom <sup>(3)</sup>
8	W2	✓	✗	✗	10 - 120 %	Nom <sup>(3)</sup>
9	W3	✓	✗	✗	10 - 120 %	Nom <sup>(3)</sup>

Parameter No.	Parameter	3P 4W	3P 3W	1P 2W	Trip Point Set Range	100% Value
10	VA1	✓	✗	✓	10 - 120 %	Nom <sup>(3)</sup>
11	VA2	✓	✗	✗	10 - 120 %	Nom <sup>(3)</sup>
12	<b>VA3</b>	✓	✗	✗	10 - 120 %	Nom <sup>(3)</sup>
13	VAR1	✓	✗	✓	10 - 120 %	Nom <sup>(3)</sup>
14	VAR2	✓	✗	✗	10 - 120 %	Nom <sup>(3)</sup>
15	VAR3	✓	✗	✗	10 - 120 %	Nom <sup>(3)</sup>
16	PF1#	✓	✗	✓	10 - 100 %	360°
17	PF2#	✓	✗	✗	10 - 100 %	360°
18	PF3#	✓	✗	✗	10 - 100 %	360°
19	PA1#	✓	✗	✓	10 - 100 %	360°
20	PA2#	✓	✗	✗	10 - 100 %	360°
21	PA3#	✓	✗	✗	10 - 100 %	360°
22	Volts Ave.	✓	✓	✗	10 - 120 %	Vnom <sup>(2)</sup>
24	Current Ave.	✓	✓	✗	10 - 120 %	Inom
27	Watts sum	✓	✓	✗	10 - 120 %	Nom <sup>(3)</sup>
29	VA sum	✓	✓	✗	10 - 120 %	Nom <sup>(3)</sup>
31	VAR sum	✓	✓	✗	10 - 120 %	Nom <sup>(3)</sup>
32	PF Ave.#	✓	✓	✗	10 - 100 %	360°
34	PA Ave.#	✓	✓	✗	10 - 100 %	360°
36	Freq.	✓	✓	✓	10 - 100 %	70Hz <sup>(1)</sup>
43	Watt Demand Imp.	✓	✓	✓	10 - 120 %	Nom <sup>(3)</sup>
44	Watt Max Demand Imp.	✓	✓	✓	10 - 120 %	Nom <sup>(3)</sup>
45	Watt Demand Exp	✓	✓	✓	10 - 120 %	Nom <sup>(3)</sup>
46	Watt Demand Max Exp	✓	✓	✓	10 - 120 %	Nom <sup>(3)</sup>
51	VA Demand	✓	✓	✓	10 - 120 %	Nom <sup>(3)</sup>

52	VA Max Demand.	✓	✓	✓	10 - 120 %	Nom <sup>(3)</sup>
53	Current Demand.	✓	✓	✓	10 - 120 %	Inom
54	Current Max Demand.	✓	✓	✓	10 - 120 %	Inom
101	VL1-L2	✓	✗	✗	10 - 120 %	Vnom (L-L)
102	VL2-L3	✓	✗	✗	10 - 120 %	Vnom (L-L)
103	VL3-L1	✓	✗	✗	10 - 120 %	Vnom (L-L)

**Note : Parameters 1,2,3 are L-N Voltage for 3P 4W & L-L Voltage for 3P 3W.**

- (1) For Frequency 0% corresponds to 40Hz and 100% corresponds to 70Hz.
- (2) For 3P 4wire and 1ph the nominal value is  $V_{LN}$  and that for 3P3W is  $V_{LL}$ .
- (3) Nominal value for power is calculated from nominal Voltage and current values.
- (4) Nominal Value is to be considered with set CT/ PT Primary values.
- (5) For single phase L1 Phase values are to be considered as System values.

## 8. Relay output (Optional) :

The Multifunction Meter is provided with relay for pulse output as well as for limit switch.

### 8.1 Pulse Output :

Pulse output is the potential free, very fast acting relay contact which can be used to drive an external mechanical counter for energy measurement. The Multifunction Meter pulse output can be configured to any of the following parameter through setup parameter screen

- 1) Active Energy (Import)
- 2) Active Energy (Export)
- 3) Reactive Energy (Import)
- 4) Reactive Energy (Export)
- 5) Apparent Energy

#### 2. For Energy Output in Kwhr

Divisor	Pulse rate	
	Pulse	System Power*
1	1per 1000WWhr	Up to 3600kW
	1per 1000kWhr	Up to 3600kW
	1per 1000MWhr	Above 3600kW

**TABLE 3 : Energy Pulse Rate Divisor  
1.For Energy Output in Whr**

Divisor	Pulse rate	
	Pulse	System Power*
1	1per Whr	Up to 3600W
	1per kWhr	Up to 3600kW
	1per MWhr	Above 3600kW
10	1per 10Whr	Up to 3600W
	1per 10kWhr	Up to 3600kW
	1per 10MWhr	Above 3600kW
100	1per 100Whr	Up to 3600W
	1per 100kWhr	Up to 3600kW
	1per 100MWhr	Above 3600kW
1000	1per 1000Whr	Up to 3600W
	1per 1000kWhr	Up to 3600kW
	1per 1000MWhr	Above 3600kW
Pulse Duration 60 ms, 100 ms or 200 ms		

#### 3. For Energy Output in Mwhr

Divisor	Pulse rate	
	Pulse	System Power*
1	1per 1000 Kwhr	Up to 3600W
	1per 1000 Mwhr	Up to 3600kW
	1per 1000 Gwhr	Above 3600kW

Above options are also applicable for Apparent and Reactive Energy.

\*Note:

- 1) System power =  $3 \times CT(\text{Primary}) \times PT(\text{Primary})$   
L-N for 3 Phase 4 Wire
- 2) System power =  $\text{Root}3 \times CT(\text{Primary}) \times PT(\text{Primary})$   
L-L for 3 Phase 3 Wire
- 3) System power =  $CT(\text{Primary}) \times PT(\text{Primary})$   
L-N for 1 Phase 2 Wire

## 8.2 Limit Switch :

Limit switch can be used to monitor the measured parameter ( Ref.Table:2) in relation with to a set limit. The limit switch can be configured in one of the four mode given below:-

- 1) Hi alarm & Energized Relay..
- 2) Hi alarm & De-Energized Relay.
- 3) Lo alarm & Energized Relay.
- 4) Lo alarm & De-Energized Relay.

With User selectable Trip point, Hysteresis, Energizing Delay & De-Energizing delay.

### Hi Alarm:

If Hi-Alarm Energized or Hi Alarm De-Energized option is selected then relay will get energized or De-energized,if selected parameter is greater than or equal to trip point.

### Lo Alarm:

If Lo-Alarm Energized or Lo Alarm De-Energized option is selected then relay will get energized or De-energized, if selected parameter is less than or equal to trip point.

**# Note:** For Lo-Alarm configuration, set the values of trip point & hysteresis such that % trip point + % of hysteresis should be less than 100%.  
For example, if trip point is set 70% then maximum applicable hysteresis is 42.8%. i.e Trip point 70% (252°) + Hysteresis 42.8% (107.8°) = 359.8°  
If total value is greater than the 100% i.e. 360° then relay will not release.

### Trip point:

Trip point can be set in the range as specified in table 2 of nominal value for Hi-Alarm & 10% to 100 % of nominal value for Lo-Alarm.

### Hysteresis:

Hysteresis can be set in the range of 0.5% to 50 % of set trip point .

If Hi-alarm Energized or Hi-alarm De-energized is selected then relay will get De-energized or Energized respectively, if set parameter value is less than Hysteresis

Similarly if Lo-alarm Energized or Lo-alarm De-Energized.

**Note :** In case of lo alarm if trip point is set greater than 80% then the maximum hysteresis can be set such that the total Trip point+ Hysteresis(% of trip point value) will not exceed 120% of range.

For example :If trip point is set at 90%, then maximum 33.3% hysteresis should be set such that,  $[90 + 29.99 (33.3\% \text{ of } 90)] = 120$

### Energizing Delay:

The energizing delay can be set in the range from1 to 10 sec.

### De-Energizing Delay:

The De-energizing delay can be set in the range from1 to 10 sec.

### Example of different configuration.

Parameter No. 4 (Current1)

Trip Point = 50%

Hysteresis = 50% of trip point

Energising Delay:2S

De-energising Delay:2S

### 1) Hi alarm & Energised relay

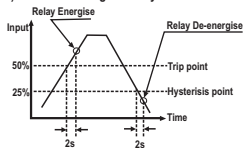

### 2) Hi alarm & De-energise relay

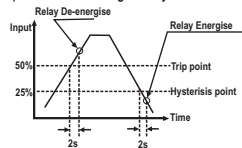

### 3) Lo alarm & Energised relay

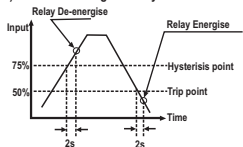

### 4) Lo alarm & De-energise relay

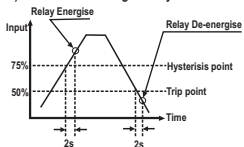

## 9. RS 485 ( ModBus ) Output :

THE MULTIFUNCTION METER supports MODBUS (RS485) RTU protocol( 2-wire ).

Connection should be made using twisted pair shielded cable. All "A" and "B" connections are daisy chained together. The screens should also be connected to the "Gnd" terminal. To avoid the possibility of loop currents, an Earth connection should be made at one point on the network. Loop (ring) topology does not require any termination load. Line topology may or may not require terminating loads depending on the type and length of cable used. The impedance of the termination load should match the impedance of the cable and be at both ends of the line. The cable should be terminated at each end with a 120 ohm (1/4 Watt min.) resistor.

RS 485 network supports maximum length of 1.2km. Including the Master, a maximum of 32 instruments can be connected in RS485 network. The permissible address range for The Multifunction Meter is between 1 and 247 for 32 instruments. Broadcast Mode (address 0) is not allowed.

The maximum latency time of an Multifunction Meter is 200ms i.e. this is the amount of time that can pass before the first response character is output.

After sending any query through software (of the Master), it must allow 200ms of time to elapse before assuming that the Multifunction Meter is not going to respond. If slave does not respond within 200 ms, Master can ignore the previous query and can issue fresh query to the slave.

The each byte in RTU mode has following format:

	8-bit binary, hexadecimal 0-9, A-F 2 hexadecimal characters contained in each 8-bit field of the message
<b>Format of Data Bytes</b>	4 bytes (32 bits) per parameter. Floating point format ( to IEEE 754) Most significant byte first (Alternative least significant byte first)
<b>Error Checking Bytes</b>	2 byte Cyclical Redundancy Check (CRC)
<b>Byte format</b>	1 start bit, 8 data bits, least significant bit sent first 1 bit for even/odd parity 1 stop bit if parity is used; 1 or 2 bits if no parity

Communication Baud Rate is user selectable from the front panel between 2400, 4800, 9600, 19200 bps.

#### Function code :

03	Read Holding Registers	Read content of read /write location ( 4X )
04	Read input Registers	Read content of read only location ( 3X )
16	Presets Multiple Registers	Set the content of read / write locations ( 4X )

**Exception Cases :** An exception code will be generated when Meter receives ModBus query with valid parity & error check but which contains some other error ( e.g. Attempt to set floating point variable to an invalid value) The response generated will be "Function code" ORed with HEX (80H ). The exception codes are listed below

01	Illegal function	The function code is not supported by Meter
02	Illegal Data Address	Attempt to access an invalid address or an attempt to read or write part of a floating point value
03	Illegal DataValue	Attempt to set a floating point variable to an invalid value

#### Accessing 3 X register for reading measured values:

Two consecutive 16 bit registers represent one parameter. Refer table 4 for the addresses of 3X registers (Parameters measured by the instruments). Each parameter is held in the 3X registers. Modbus Code 04 is used to access all parameters.

#### Example :

To read parameter ,

Volts 3 : Start address= 04 (Hex)      Number of registers = 02

**Note : Number of registers = Number of parameters x 2**

Each Query for reading the data must be restricted to 20 parameters or less. Exceeding the 20 parameter limit will cause a ModBus exception code to be returned.

**Query :**

01 (Hex)	04 (Hex)	00 (Hex)	04(Hex)	00 (Hex)	02(Hex)	30 (Hex)	0A (Hex)
Device Address	Function Code	Start Address High	Start Address Low	Number of Registers Hi	Number of Registers Lo	CRC Low	CRC High

Start Address High : Most significant 8 bits of starting address of the parameter requested.

Start Address low :Least significant 8 bits of starting address of the parameter requested.

Number of register Hi : Most significant 8 bits of Number of registers requested.

Number of register Lo : Least significant 8 bits of Number of registers requested.

**(Note : Two consecutive 16 bit register represent one parameter.)**

**Response: Volt3 (219.25V)**

01 (Hex)	04 (Hex)	04 (Hex)	43 (Hex)	5B (Hex)	41 (Hex)	21 (Hex)	6F (Hex)	9B (Hex)
Device Address	Function Code	Byte Count	Data Register1 High Byte	Data Register1 Low Byte	Data Register2 High Byte	Data Register2 Low Byte	CRC Low	CRC High

Byte Count : Total number of data bytes received.

Data register 1 High Byte : Most significant 8 bits of Data register 1 of the parameter requested.

Data register 1 Low Byte : Least significant 8 bits of Data register 1 of the parameter requested.

Data register 2 High Byte : Most significant 8 bits of Data register 2 of the parameter requested.

Data register 2 Low Byte : Least significant 8 bits of Data register 2 of the parameter requested.

**(Note : Two consecutive 16 bit register represent one parameter.)**

**Table 4 : 3 X register addresses (measured parameters)**

Address (Register)	Parameter No.	Parameter	Modbus Start Address Hex		3P 4W	3P 3W	1PH
			High Byte	Low Byte			
30001	1	Volts 1	00	0	✓	✓	✓
30003	2	Volts 2	00	2	✓	✓	✗
30005	3	Volts 3	00	4	✓	✓	✗
30007	4	Current 1	00	6	✓	✓	✓
30009	5	Current 2	00	8	✓	✓	✗
30011	6	Current 3	00	A	✓	✓	✗
30013	7	W1	00	C	✓	✗	✓
30015	8	W2	00	E	✓	✗	✗

Address (Register)	Parameter No.	Parameter	Modbus Start Address Hex		3P 4W	3P 3W	1PH
			High Byte	Low Byte			
30017	9	W3	00	10	✓	✗	✗
30019	10	VA1	00	12	✓	✗	✓
30021	11	VA2	00	14	✓	✗	✗
30023	12	VA3	00	16	✓	✗	✗
30025	13	VAR1	00	18	✓	✗	✓
30027	14	VAR2	00	1A	✓	✗	✗
30029	15	VAR3	00	1C	✓	✗	✗
30031	16	PF1	00	1E	✓	✗	✓
30033	17	PF2	00	20	✓	✗	✗
30035	18	PF3	00	22	✓	✗	✗
30037	19	Phase Angle 1	00	24	✓	✗	✓
30039	20	Phase Angle 2	00	26	✓	✗	✗
30041	21	Phase Angle 3	00	28	✓	✗	✗
30043	22	Volts Ave	00	2A	✓	✓	✓
30045	23	Volts Sum	00	2C	✓	✓	✗
30047	24	Current Ave	00	2E	✓	✓	✓
30049	25	Current Sum	00	30	✓	✓	✗
30051	26	Watts Ave	00	32	✓	✓	✗
30053	27	Watts Sum	00	34	✓	✓	✓
30055	28	VA Ave	00	36	✓	✓	✗
30057	29	VA Sum	00	38	✓	✓	✓
30059	30	VAr Ave	00	3A	✓	✓	✗
30061	31	VAr Sum	00	3C	✓	✓	✓
30063	32	PF Ave	00	3E	✓	✓	✓
30065	33	PF Sum	00	40	✓	✗	✗
30067	34	Phase Angle Ave	00	42	✓	✓	✓
30069	35	Phase Angle Sum	00	44	✓	✗	✗
30071	36	Freq	00	46	✓	✓	✓
30073	37	Wh Import	00	48	✓	✓	✓
30075	38	Wh Export	00	4A	✓	✓	✓
30077	39	VARh Import	00	4C	✓	✓	✓
30079	40	VARh Export	00	4E	✓	✓	✓
30081	41	VAh	00	50	✓	✓	✓

**Table 4 : Continued...**

Address (Register)	Parameter No.	Parameter	Modbus Start Address Hex		3P 4W	3P 3W	1PH
			High Byte	Low Byte			
30085	43	W Demand (Import)	00	54	✓	✓	✓
30087	44	W Max Demand (Import)	00	56	✓	✓	✓
30089	45	W Demand (Export)	00	58	✓	✓	✓
30091	46	W Max Demand (Export)	00	5A	✓	✓	✓
30101	51	VA Demand	00	64	✓	✓	✓
30103	52	VA Max Demand	00	66	✓	✓	✓
30105	53	A Demand	00	68	✓	✓	✓
30107	54	A Max Demand	00	6A	✓	✓	✓
30133	67	Volts Ave Max	00	84	✓	✓	✓
30135	68	Volts Ave Min	00	86	✓	✓	✓
30141	71	Current Ave Max	00	8C	✓	✓	✓
30143	72	Current Ave Min	00	8E	✓	✓	✓
30201	101	VL 1 - 2 ( Calculated )	00	C8	✓	✗	✗
30203	102	VL 2 - 3 ( Calculated )	00	CA	✓	✗	✗
30205	103	VL 3 - 1 ( Calculated )	00	CC	✓	✗	✗
30227	114	Run Hour	00	E2	✓	✓	✓
30229	115	On Hour	00	E4	✓	✓	✓
30231	116	No. Of Interrupts	00	E6	✓	✓	✓

**Note :** Parameters 1,2,3 are L-N Voltage for 3P 4W & L-L Voltage for 3P 3W .

### Accessing 4 X register for Reading & Writing :

Each setting is held in the 4X registers. ModBus code 03 is used to read the current setting & code 16 is used to write/change the setting. Refer **Table 5** for 4 X Register addresses.

#### Example : Reading System type

System type : Start address= 0A (Hex)

Number of registers = 02

**Note :** Number of registers = Number of Parameters x 2

#### Query :

Device Address	01 (Hex)
Function Code	03 (Hex)
Start Address High	00 (Hex)
Start Address Low	0A (Hex)
Number of Registers Hi	00 (Hex)
Number of Registers Lo	02 (Hex)
CRC Low	E4 (Hex)
CRC High	09 (Hex)

Start Address High : Most significant 8 bits of starting address of the parameter requested.

Start Address low : Least significant 8 bits of starting address of the parameter requested.

Number of register Hi : Most significant 8 bits of Number of registers requested.

Number of register Lo : Least significant 8 bits of Number of registers requested.

**(Note : Two consecutive 16 bit register represent one parameter.)**

### Response: System Type (3phase 4 wire = 3)

Device Address	01 (Hex)
Function Code	03 (Hex)
Byte Count	04 (Hex)
Data Register1 High Byte	40 (Hex)
Data Register1Low Byte	40 (Hex)
Data Register2 High Byte	00 (Hex)
Data Register2 Low Byte	00(Hex)
CRC Low	EE (Hex)
CRC High	27 (Hex)

Byte Count : Total number of data bytes received.

Data register 1 High Byte : Most significant 8 bits of Data register 1 of the parameter requested.

Data register 1 Low Byte : Least significant 8 bits of Data register 1 of the parameter requested.

Data register 2 High Byte : Most significant 8 bits of Data register 2 of the parameter requested.

Data register 2 Low Byte : Least significant 8 bits of Data register 2 of the parameter requested.

**(Note : Two consecutive 16 bit register represent one parameter.)**

### Example : Writing System type

System type : Start address= 0A (Hex)

Number of registers = 02

**Query:( Change System type to 3phase 3wire = 2 )**

Device Address	01 (Hex)
Function Code	10 (Hex)
Starting Address Hi	00 (Hex)
Starting Address Lo	0A(Hex)
Number of Registers Hi	00 (Hex)
Number of Registers Lo	02(Hex)
Byte Count	04 (Hex)
Data Register-1High Byte	40 (Hex)
Data Register-1 Low Byte	00(Hex)
Data Register-2 High Byte	00(Hex)
Data Register-2 Low Byte	00(Hex)
CRC Low	66 (Hex)
CRC High	10 (Hex)

Byte Count : Total number of data bytes received.

Data register 1 High Byte : Most significant 8 bits of Data register 1 of the parameter requested.

Data register 1 Low Byte : Least significant 8 bits of Data register 1 of the parameter requested.

Data register 2 High Byte : Most significant 8 bits of Data register 2 of the parameter requested.

Data register 2 Low Byte : Least significant 8 bits of Data register 2 of the parameter requested.

**(Note : Two consecutive 16 bit register represent one parameter.)**

**Response:**

Device Address	01 (Hex)
Function Code	10 (Hex)
Start Address High	00 (Hex)
Start Address Low	0A(Hex)
Number of Registers Hi	00 (Hex)
Number of Registers Lo	02(Hex)
CRC Low	61 (Hex)
CRC High	CA (Hex)

Start Address High : Most significant 8 bits of starting address of the parameter requested.

Start Address low : Least significant 8 bits of starting address of the parameter requested.

Number of register Hi : Most significant 8 bits of Number of registers requested.

Number of register Lo : Least significant 8 bits of Number of registers requested.

**(Note : Two consecutive 16 bit register represent one parameter.)**

**Table 5 : 4 X register addresses**

Address (Register)	Parameter No.	Parameter	Read / Write	Modbus Start Address Hex	
				High Byte	Low Byte
40001	1	Demand Reset	Wp	00	00
40003	2	Demand Period	R/Wp	00	02
40005	3	Energy display on modbus	R/Wp	00	04
40007	4	Sys Voltage	R	00	06
<b>40009</b>	<b>5</b>	Sys Current	<b>R</b>	<b>00</b>	<b>08</b>
40011	6	Sys Type	R/Wp	00	0A
40013	7	Pulse Width	R/Wp	00	0C
40015	8	Energy Reset	Wp	00	0E
40017	9	Run/On Hour & Interruption Reset	Wp	00	10
40019	10	RS 485 Set-up Code	R/Wp	00	12
<b>40021</b>	<b>11</b>	Node Address.	R/Wp	<b>00</b>	<b>14</b>
<b>40023</b>	<b>12</b>	<b>Pulse Divisor</b>	R/Wp	<b>00</b>	<b>16</b>
40025	13	Min Reset	Wp	00	18
40027	14	Max Reset	Wp	00	1A
40029	15	-	-	-	-
40031	16	-	-	-	-

Address (Register)	Parameter No.	Parameter	Read / Write	Modbus Start Address Hex	
				High Byte	Low Byte
40033	17	PT Primary	R/Wp	00	20
40035	18	CT Primary	R/Wp	00	22
40037	19	System Power	R	00	24
40039	20	Energy Digit reset count	R/Wp	00	26
40041	21	Register Order/Word Order	R/Wp	00	28
40043	22	CT Secondary	R/Wp	00	2A
40045	23	PT Secondary	R/Wp	00	2C
40047	24	Relay output select	R/Wp	00	2E
40049	25	Pulse/Limit Parameter select	R/Wp	00	30
40051	26	Limit Trip point	R/Wp	00	32
40053	27	Hysteresis	R/Wp	00	34
40055	28	Limit delay(On)	R/Wp	00	36
40057	29	Limit delay(Off)	R/Wp	00	38
40059	30	-	-	-	-
40061	31	-	-	-	-
40063	32	-	-	-	-
40065	33	-	-	-	-
40067	34	-	-	-	-
40069	35	-	-	-	-
40071	36	Password	R/W	00	46
40073	37	Limit Configuration select	R/Wp	00	48
40075	38	-	-	-	-
40077	39	Auto scroll	R/Wp	00	4C
40079	40	30mA Noise Current Elimination	R/Wp	00	4E

## Explanation for 4 X register :

Address	Parameter	Description
40001	Demand Reset	Demand Reset is used to reset the Demand parameter. A value of zero must be Written to this register to reset the Demand. Writing any other value will return an error.
40003	Demand Period	Demand period represents demand time in minutes. The applicable values are 8,15,20 or 30. Writing any other value will return an error.
40005	Energy display on Modbus	This address is used to set energy output in Wh,KWh & MWh. Write one of the following value to this address. 1 = Energy in Wh.                      2 = Energy in KWh. 3 = Energy in MWh.
40007	System Voltage	This address is read only and displays System Voltage
40009	System Current	This address is read only and displays System Current
40011	System Type	This address is used to set the System type. Write one of the following value to this address. 1 = 1 Phase 2 Wire 2 = 3 Phase 3 Wire 3 = 3 Phase 4 Wire. Writing any other value will return error .
40013	Pulse Width of Relay	This address is used to set <b>pulse width</b> of the Pulse output. Write one of the following values to this address: 60 : 60 ms 100 : 100 ms 200 : 200 ms Writing any other value will return error .
40015	Reset Energy Counter	This address is used to reset the Energy Counter. Write zero value to this register to reset the energy counter. Writing any other value will return an error.
40017	Run/On Hour & Interruption reset	This address is used to reset the Run/On hour & number of Interruption . Write zero value to this register to reset the Run/On hour & number of Interruption. Writing any other value will return an error.
40019	Rs485 Set-up Code	This address is used to set the baud rate, Parity, Number of stop bits. Refer to Table 6 for details.
40021	Node Address	This register address is used to set Device address between 1 to 247 .

40023	Pulse Divisor	This address is used to set <b>pulse divisor</b> of the Pulse output. Write one of the following values to this address <b>for Wh</b> : <b>1</b> : Divisor 1 <b>10</b> : Divisor 10 <b>100</b> : Divisor 100 <b>1000</b> : Divisor 1000 & In <b>KWH</b> or <b>MWh</b> divisor will be <b>1 default</b> . Writing any other value will return an error.
40025	Min - Reset	This address is used to reset the Min parameters value. Write Zero value to this register to reset the Min parameters. Writing any other value will return an error.
40027	Max - Reset	This address is used to reset the Max parameters value. Write Zero value to this register to reset the Max parameters. Writing any other value will return an error.
40033	PT Primary	This address allows the user to set PT Primary value. The maximum settable value is 692.8kVL-L for all system types & also depends on the per phase 1000MVA Restriction of power combined with CT primary
40035	CT Primary	This address allows the user to set CT Primary value. The maximum settable value is 9999 & also depends on the per phase 1000MVA Restriction of power combined with PT primary
40037	Sys Power	System Power (Read Only) is the Nominal system power based on the values of Nominal system volts and Nominal system current.
40039	Energy digit Reset Count	This address is used to reset Energy Digit count value.If Energy output in Wh count will be reset in between 7 to 14.Or In KWh reset in between 7 to 12 & In MWh reset in between 7 to 9
40041	Word Order	Word Order controls the order in which Multifunction Meter receives or sends floating - point numbers:- normal or reversed register order . In normal mode, the two registers that make up a floating point numbers are sent most significant bytes first. In reversed register mode , the two registers that make up a floating point numbers are sent least significant bytes first. To set the mode, write the value ' 2141.0' into this register-the instrument will detect the order used to send this value and set that order for all ModBus transaction involving floating point numbers.
40043	CT secondary	This address is used to read and write the CT secondary value. write one of the following values to this address. 1=1A CT secondary 5=5A CT secondary writing any other value will return an error.
40045	PT secondary	This address is used to read and write the PT secondary value. Ref Table for the range of PT secondary settable values in Section 3.2.1.3

40047	Relay output select	This address is used to select the Relay operation as pulse or Limit. write one of the following values to this address. 0 = Pulse output on Relay 128 (Decimal) = Limit output on Relay. Writing any other value will return an error.
40049	Pulse /Limit parameter select	This address is used to assign the Parameter to Relay If Limit option is selected refer table 2 for parameter number & if Pulse option is selected then refer table 7.
40051	Limit Trip Point	This address is used to set the trip point in %. Any value between 10 to 100 for Lo- alarm & 10 to 120 (refer table 2) for Hi-alarm can be written to this address. Writing any other value will return an error.
40053	Hysteresis	This address is used to set the hysteresis between 0.5 to 50 . Writing any other value will return an error.
40055	Limit Energizing Delay	This address is used to set the Energizing delay between 1 to 10 . Writing any other value will return an error.
40057	Limit de-energizing Delay	This address is used to set the De-Energizing delay between 1 to 10 . Writing any other value will return an error.
40071	Password	This address is used to set & reset the password. Valid Range of Password can be set is 0000 - 9999 . 1) If password lock is present & if this location is read it will return <b>zero</b> . 2) If Password lock is absent & if this location is read it will return <b>One</b> . 3) If password lock is present & to disable this lock first send valid password to this location then write "0000" to this location 4) If password lock is present & to modify 4X parameter first send valid password to this location so that 4X parameter will be accessible for modification. 5) If for in any of the above case invalid password is send then meter will return exceptional error 2.
40073	Limit Configuration Select	This address is used to set the Configuration for relay see table 8. Writing any other value will return an error.
40077	Auto scroll	This address is used to activate or de-activate the auto scrolling. Write 0-Deactivate 1-Activate, Writing any other value will return an error.
40079	30mA Noise current Elimination	This address is used to activate or de-activate the 30 mA noise current elimination write 0-Deactivate 30 (Decimal)-Activate Writing any other value will return an error.

**Table 6 : RS 485 Set-up Code**

Baud Rate	Parity	Stop Bit	Decimal value
19200	NONE	01	12
19200	NONE	02	13
19200	EVEN	01	14
19200	ODD	01	15
9600	NONE	01	08
9600	NONE	02	09
9600	EVEN	01	10
9600	ODD	01	11
4800	NONE	01	04
4800	NONE	02	05
4800	EVEN	01	06
4800	ODD	01	07
2400	NONE	01	00
2400	NONE	02	01
2400	EVEN	01	02
2400	ODD	01	03

**NOTE :** Codes not listed in the table above may give rise to unpredictable results including loss of communication. Exercise caution when attempting to change mode via direct Modbus writes.

**Table 7 : Pulse Configuration select**

Code	Configuration
0	Import Active Energy
1	Export Active Energy
2	Import Reactive Energy
3	Export Reactive Energy
4	Apparent Energy

**Table 8 :Limit Configuration select**

Code	Configuration
0	Hi- alarm & Energized relay
1	Hi- alarm & De-energized relay
2	Lo- alarm & Energized relay
3	Lo- alarm & De-energized relay

**9.1 User Assignable Modbus Registers:**

The Multifunction Meter contains the 20 user assignable registers in the address range of 0x200 (30513) to 0x226 (30551) (see Table 9).

Any of the parameter addresses ( 3X register addresses Table 4)) accessible in the instrument can be mapped to these 20 user assignable registers.

Parameters (3X registers addresses ) that resides in different locations may be accessed by the single request by re-mapping them to adjacent address in the user assignable registers area.

The actual address of the parameters ( 3X registers addresses) which are to be assessed via address 0x200 to 0x226 are specified in 4x Register 0x200 to 0x213 (see Table 10).

**Table 9 : User Assignable 3X Data Registers**

Address (Register)	Parameter Number.	Assignable Register	Modbus Start Address (Hex)	
			High Byte	Low Byte
30513	257	Assignable Reg 1	02	00
30515	258	Assignable Reg 2	02	02
30517	259	Assignable Reg 3	02	04
30519	260	Assignable Reg 4	02	06
30521	261	Assignable Reg 5	02	08
30523	262	Assignable Reg 6	02	0A
30525	263	Assignable Reg 7	02	0C
30527	264	Assignable Reg 8	02	0E
30529	265	Assignable Reg 9	02	10
30531	266	Assignable Reg 10	02	12
30533	267	Assignable Reg 11	02	14
30535	268	Assignable Reg 12	02	16
30537	269	Assignable Reg 13	02	18
30539	270	Assignable Reg 14	02	1A
30541	271	Assignable Reg 15	02	1C
30543	272	Assignable Reg 16	02	1E
30545	273	Assignable Reg 17	02	20
30547	274	Assignable Reg 18	02	22
30549	275	Assignable Reg 19	02	24
30551	276	Assignable Reg 20	02	26

**Table 10 : User Assignable mapping register ( 4X registers)**

Address (Register)	Parameter Number.	Mapping Register	Modbus Start Address (Hex)	
			High Byte	Low Byte
40513	257	Mapped Add for register #0x0200	02	00
40514	258	Mapped Add for register #0x0202	02	01
40515	259	Mapped Add for register #0x0204	02	02

**Table 10 Continued**

40516	260	Mapped Add for register #0x0206	02	03
40517	261	Mapped Add for register #0x0208	02	04
40518	262	Mapped Add for register #0x020A	02	05
40519	263	Mapped Add for register #0x020C	02	06
40520	264	Mapped Add for register #0x020E	02	07
40521	265	Mapped Add for register #0x0210	02	08
40522	266	Mapped Add for register #0x0212	02	09
40523	267	Mapped Add for register #0x0214	02	0A
40524	268	Mapped Add for register #0x0216	02	0B
40527	269	Mapped Add for register #0x0218	02	0C
40528	270	Mapped Add for register #0x021A	02	0D
40529	271	Mapped Add for register #0x021C	02	0E
40530	272	Mapped Add for register #0x021E	02	0F
40531	273	Mapped Add for register #0x0220	02	10
40532	274	Mapped Add for register #0x0222	02	11
40533	275	Mapped Add for register #0x0224	02	12
40534	276	Mapped Add for register #0x0226	02	13

**Example : Assigning parameter to user assignable registers**

To access the voltage2 (3X address 0x0002) and Power Factor1 (3X address 0x001E) through user assignable register assign these addresses to 4x register (Table 10 ) 0x0200 and 0x0201 respectively .

**Assigning Query:**

Device Address	01 (Hex)
Function Code	10 (Hex)
Starting Address Hi	02 (Hex)
Starting Address Lo	00 (Hex)
Number of Registers Hi	00 (Hex)*
Number of Registers Lo	02(Hex)*
Byte Count	04 (Hex)

Data Register-1High Byte	00 (Hex)
Data Register-1 Low Byte	02 (Hex)
Data Register-2 High Byte	00 (Hex)
Data Register-2 Low Byte	1E (Hex)
CRC Low	CB (Hex)
CRC High	07 (Hex)

} Voltage 2 \*  
(3X Address  
0x0002)  
} Power Factor  
1 \*(3X Address  
0x001E)

\* Note : Parameters should be assigned in Multiple of two i.e. 2,4,6,8.....20.

Response :

Device Address	01 (Hex)
Function Code	10 (Hex)
Start Address High	02 (Hex)
Start Address Low	00 (Hex)
Number of Registers Hi	00 (Hex)
Number of Registers Lo	02 (Hex)
CRC Low	40 (Hex)
CRC High	70 (Hex)

#### Reading Parameter data through User Assignable Registers:

In assigning query Voltage 2 & Power Factor 1 parameters were assigned to 0x200 & 0x201 (Table10) which will point to user assignable 3x registers 0x200 and 0x202 (table9). So to read Voltage2 and Power Factor1 data reading query should be as below.

#### Query:

Device Address	01 (Hex)
Function Code	04 (Hex)
Start Address High	02 (Hex)
Start Address Low	00 (Hex)
Number of Registers Hi	00 (Hex)
Number of Registers Lo	04 (Hex)**
CRC Low	F0 (Hex)
CRC High	71 (Hex)

Start Address High : Most significant 8 bits of starting address of User assignable register.

Start Address low :Least significant 8 bits of starting address of User assignable register.

Number of register Hi : Most significant 8 bits of Number of registers requested.

Number of register Lo : Least significant 8 bits of Number of registers requested.

**\*\*Note : Two consecutive 16 bit register represent one parameter. Since two parameters are requested four registers are required**

Response : (Volt2 = 219.30 / Power Factor1 = 1.0)

Device Address	01 (Hex)
Function Code	04 (Hex)
Byte count	08 (Hex)
Data Register-1 High Byte	43 (Hex)
Data Register-1 Low Byte	5B (Hex)
Data Register-2 High Byte	4E (Hex)
Data Register-2 Low Byte	04 (Hex)
Data Register-3 High Byte	3F (Hex)
Data Register-3 Low Byte	80 (Hex)
Data Register-4 High Byte	00 (Hex)
Data Register-4 Low Byte	00 (Hex)
CRC Low	79 (Hex)
CRC High	3F (Hex)

} Voltage  
2 Data

} Power  
Factor  
1 Data

User Assignable mapping Registers (Starting Address) ( 4X Registers Table10 )		User Assignable Data Registers (Starting Address) ( 3X Registers Table 9 )	
0x200	Voltage 2 (0x0002)	0x200	0x201 (16 bit)
0x201	Power Factor 1 (0x001E)	0x202	0x202 (16 bit)
0x202	Wh Import (0x0048)	0x204	0x204 (16 bit)
0x203	Frequency (0x0046)	0x206	0x206 (16 bit)
⋮	⋮	⋮	⋮
0x212	Current 1 (0x0006)	0x224	0x224 (16 bit)
0x213	VAh (0x0050)	0x226	0x226 (16 bit)
			0x207 (16 bit)
			0x205 (16 bit)
			0x203 (16 bit)

**To get the data through User assignable Register use following steps:**

- 1) Assign starting addresses(Table3) of parameters of interest to a "User assignable mapping registers" in a sequence in which they are to be accessed (see section "Assigning parameter to user assignable registers")
- 2) Once the parameters are mapped data can be acquired by using "User assignable data register "Starting address . i.e to access data of Voltage2, Power factor1,Wh import, Frequency send query with starting address 0x200 with number of register 8 or individually parameters can be accessed for example if current1 to be accessed use starting address 0x212. (See section **Reading Parameter data through User Assignable Registers**)

## 10. Phaser Diagram :

**Quadrant 1:** 0° to 90°

**Quadrant 2:** 90° to 180°

**Quadrant 3:** 180° to 270°

**Quadrant 4:** 270° to 360°

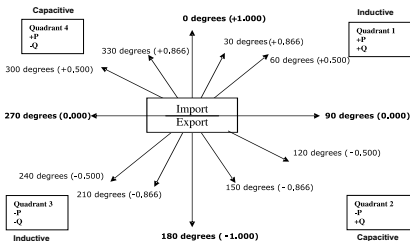

Connections	Quadrant	Sign of Active Power ( P )	Sign of Reactive Power ( Q )	Sign of Power Factor ( PF )	Inductive / Capacitive
Import	1	+ P	+ Q	+	L
Import	4	+ P	- Q	+	C
Export	2	- P	+ Q	-	C
Export	3	- P	- Q	-	L

Inductive means Current lags Voltage

Capacitive means Current leads Voltage

When Multifunction Meter displays Active power ( P ) with “ + ” ( positive sign ), the connection is “ **Import** ” .

When Multifunction Meter displays Active power ( P ) with “ - ” ( negative sign ), the connection is “ **Export** ” .

## 11. Installation

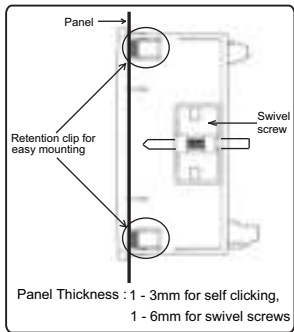

### Caution

1. In the interest of safety and functionality this product must be installed by a qualified engineer, abiding by any local regulations.
2. Voltages dangerous to human life are present at some of the terminal connections of this unit. Ensure that all supplies are de-energised before attempting any connection or disconnection.
3. These products do not have internal fuses therefore external fuses must be used to ensure safety under fault conditions.

Mounting of Multifunction Meter is featured with easy “Clip- in” mounting. Push the meter in panel slot (size 92 x92 mm), it will click fit into panel with the four integral retention clips on two sides of meter. If required Additional support is provided with swivel screws as shown in figure. The front of the enclosure conforms to IP50. Additional protection to the panel may be obtained by the use of an Optional panel gasket. The terminals at the rear of the product should be protected from liquids. The Multifunction Meter should be mounted in a reasonably stable ambient temperature and where the operating temperature is within the range 0 to 50°C. Vibration should be kept to a minimum and the product should not be mounted where it will be subjected to excessive direct sunlight.

## 11.1 EMC Installation Requirements

This product has been designed to meet the certification of the EU directives when installed to a good code of practice for EMC in industrial environments, e.g.

1. Screened output and low signal input leads or have provision for fitting RF suppression components, such as ferrite absorbers, line filters etc., in the event that RF fields cause problems.

**Note:** It is good practice to install sensitive electronic instruments that are performing critical functions, in EMC enclosures that protect against electrical interference which could cause a disturbance in function.

2. Avoid routing leads alongside cables and products that are, or could be, a source of interference.
3. To protect the product against permanent damage, surge transients must be limited to 2kV pk. It is good EMC practice to suppress differential surges to 2kV at the source. The unit has been designed to automatically recover in the event of a high level of transients. In extreme circumstances it may be necessary to temporarily disconnect the auxiliary supply for a period of greater than 5 seconds to restore correct operation. The Current inputs of these products are designed for connection in to systems via Current Transformers only, where one side is grounded.
4. ESD precautions must be taken at all times when handling this product.

## 11.2 Case Dimension & Panel Cut Out

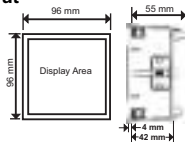

### With optional MODBUS / Limit switch.

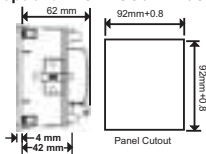

## 11.3 Wiring

Input connections are made directly to screw-type terminals with indirect wire pressure. Numbering is clearly marked on the connector. Choice of cable should meet local regulations. Terminal for both Current and Voltage inputs will accept upto 4mm<sup>2</sup> (12AWG) solid or 2.5 mm<sup>2</sup> stranded cable.

**Note :** It is recommended to use wire with lug for connection with meter.

## 11.4 Auxiliary Supply

Meter should ideally be powered from a dedicated supply, however powered from the signal source, provided the source remains within it may be the limits of the Chosen auxiliary voltage range.

## 11.5 Fusing

It is recommended that all voltage lines are fitted with 1 amp HRC fuse.

## 11.6 Earth/Ground Connections

For safety reasons, CT secondary connections should be grounded in accordance with local regulations.

## 12. Connection Diagrams

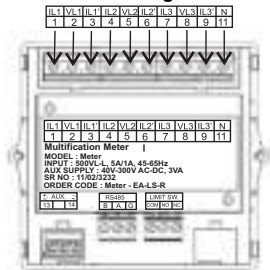

3-PHASE 3-WIRE UNBALANCED LOAD  
DIGITAL METERING SYSTEM (WITH EXTERNAL AUX.)

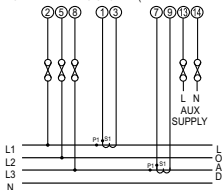

3-PHASE 4-WIRE UNBALANCED LOAD  
DIGITAL METERING SYSTEM (WITH EXTERNAL AUX.)

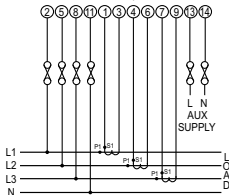

SINGLE PHASE 2-WIRE  
DIGITAL METERING SYSTEM (WITH EXTERNAL AUX.)

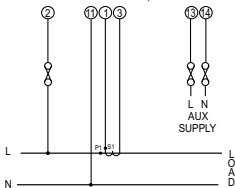

3-PHASE 4-WIRE UNBALANCED LOAD  
DIGITAL METERING SYSTEM (WITH SELF AUX.)

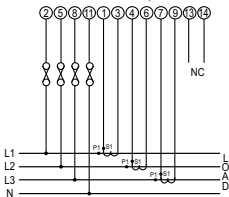

SINGLE PHASE 2-WIRE  
DIGITAL METERING SYSTEM (WITH SELF AUX.)

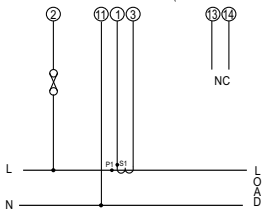

### 13. Optional Pluggable Module

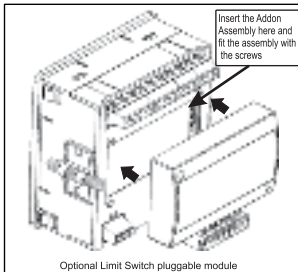

### 14. Specification :

#### System

3 Phase 3 Wire / 4 Wire or Single Phase programmable at site

#### Inputs

<b>Nominal Input Voltage</b>	500 $V_{L-L}$ ( 290 $V_{LN}$ ) AC RMS
System PT Primary Values	100 $V_{L-L}$ to 692 $kV_{L-L}$ , programmable at site
System PT Secondary Values	100 $V_{L-L}$ to 500 $V_{L-L}$ , programmable at site
Max continuous input voltage	120% of Rated Value
Nominal input voltage burden	0.3VA approx. per Phase (for ext. Aux. Meter)
<b>Nominal Input Current</b>	5A / 1A AC RMS
max continuous input current	120% of rated value
Nominal input current burden	<0.2VA approx. per phase
System CT primary values	Std. Values 1 to 9999A (1 or 5 Amp secondary)
System Secondary Values	1A / 5A, programmable at site
<b>Overload withstand</b>	
Voltage input	2 x Rated Value (1s application repeated 10 times at 10s intervals)
Current input	20 x Rated Value (1s application repeated 5 times at 5 min. intervals)

## Auxiliary Supply

External Auxiliary Supply	40V to 300V AC/DC (+/- 5% Approx.)
Self Powered	Input Voltage Range from 80% to 100% of rated value (Self Powered meter is available only in 3 Phase 4W and 1 phase network. Aux input is derived from L1 phase)
Frequency Range	45 to 65 Hz
VA Burden	4 VA Approx.

## Operating Measuring Ranges

Voltage with external Aux.	10 ... 120 % of Rated Value
Voltage with Self Aux.	80 ... 120% of Rated Value
Current	10 ... 120 % of Rated Value
Frequency	45 .. 65 Hz
Power Factor	0.5 Lead ... 1 ... 0.5 Lag

## Reference conditions for Accuracy

Reference temperature	23°C ± 2°C
Input frequency	50 or 60Hz ± 2%
Input waveform	Sinusoidal (distortion factor 0.005)
Auxiliary supply voltage	Rated Value ± 1 %
Auxiliary supply frequency	Rated Value ± 1 %

Voltage Range	20 ... 100% of Nominal Value
Current Range	10 ... 100% of Nominal Value
Power / Energy	cos $\phi$ / sin $\phi$ =1 for Active / Reactive Power & Energy 10 ... 100% of Nominal Current & 20 ... 100% of Nominal Voltage.
Power Factor / Phase Angle	40 ... 100% of Nominal Current & 20 ... 100% of Nominal Voltage

## Accuracy

Voltage	± 1.0 % of Nominal Value
Current	± 1.0 % of Nominal Value
Frequency	± 0.15% of mid frequency
Active power	± 1.0 % of Nominal Value
Reactive power	± 1.0 % of Nominal Value
Apparent Power	± 1.0 % of Nominal Value
Power factor	± 2.0 % of unity
Phase angle	± 2.0 % of range
Active energy	± 1.0 % of range
Reactive energy	± 1.0 % of range
Apparent energy	± 1.0 % of range

## Influence of variations

Temperature Coefficient 0.05% /°C for Current  
(10..120% of Rated Value)

(For Rated value range of use 0... 50°C )  
Error change due to variation of an influence quantity 0.025% /°C for Voltage (10..120% of Rated Value)  
2 \* Error allowed for the reference condition applied in the test.

## Display

LED 3 line 4 digits, Display height : 14mm  
Annunciation of units Bright LED s from Back side of screen  
Update rate Approx. 4 seconds

## Controls

User Interface 4 push buttons

## Standards

EMC Immunity IEC 61326-1 : 2005  
EMC Emmision IEC 61326-1 : 2005  
Safety IEC 61010-1-2001, permanently connected use  
IP for water & dust IEC 60529

## Safety

Pollution degree 2  
Installation category III

## Isolation

High Voltage Test 1) 3.7kV RMS 50Hz for 1 minute between all electrical circuits  
2) 2.2kV RMS 50Hz for 1 minute between Rs485 input and all electrical circuits.

## Environmental conditions

Operating temperature 0 to 50 °C  
Storage temperature -25 to +70 °C  
Relative humidity 0 .. 90 % RH (Non condensing)  
Warm up time 3 minute (minimum)  
Shock 15g in 3 planes  
Vibration 10 .. 55 Hz, 0.15mm amplitude

## Enclosure

Enclosure front IP 50  
Enclosure front with seal (optional) IP 65  
Enclosure back IP 20

## Dimensions

Bezel Size 96mm x 96mm DIN 43718  
Panel cut out 92<sup>+0.8</sup>mm X 92<sup>+0.8</sup>mm  
Overall Depth 55 mm  
Panel thickness 1 - 3mm for self clicking  
1 - 6mm for swivel screws  
Weight 320 grams Approx.

## Pulse output Option

Relay 1NO + 1NC  
Switching Voltage & Current 240VDC , 5Amp.  
Default Pulse rate Divisor 1 per Wh (up to 3600W),  
1 per kWh (up to 3600kW),  
1 per MWh (above 3600 kW)

<b>Pulse rate Divisors</b>	<b>Programmable on site</b>
10	1 per 10Wh (up to 3600W), 1 per 10kWh (up to 3600kW), 1 per 10MWh (above 3600 kW)
100	1 per 10Wh (up to 3600W), 1 per 100kWh (up to 3600kW), 1 per 100MWh (above 3600 kW)
1000	1 per 1000Wh (up to 3600W), 1 per 1000kWh (up to 3600kW), 1 per 1000MWh (above 3600 kW)

Pulse Duration      60ms , 100ms or 200ms

**Note : Above conditions are also applicable for Reactive & Apparent Energy .**

**ModBus ( RS 485 ) Option :**

Protocol	ModBus ( RS 485 )
Baud Rate	19200, 9600, 4800 or 2400 (Programmable)
Parity	Odd or Even, with 1 stop bit, Or None with 1 or 2 stop bits

**15. Connection for Optional Pulse Output / RS 485 (rear view of Multifunction Meter):**

**1. Pulse Output (Limit Output)**

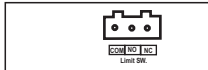

**2. RS 485 Output**

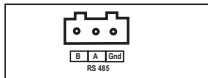

**3. Pulse (Limit) + RS 485 Output**

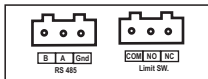

## NOTE

The Information contained in these installation instructions is for use only by installers trained to make electrical power installations and is intended to describe the correct method of installation for this product. However, 'manufacturer' has no control over the field conditions which influence product installation.

It is the user's responsibility to determine the suitability of the installation method in the user's field conditions. 'manufacturer' only obligations are responsibility to determine the suitability of the installation method in the user's field conditions. 'manufacturer' only obligations are those in 'manufacturer' standard Conditions of Sale for this product and in no case will 'manufacturer' be liable for any other incidental, indirect or consequential damages arising from the use or misuse of the products.